

EZstrip™ Transfer Pump

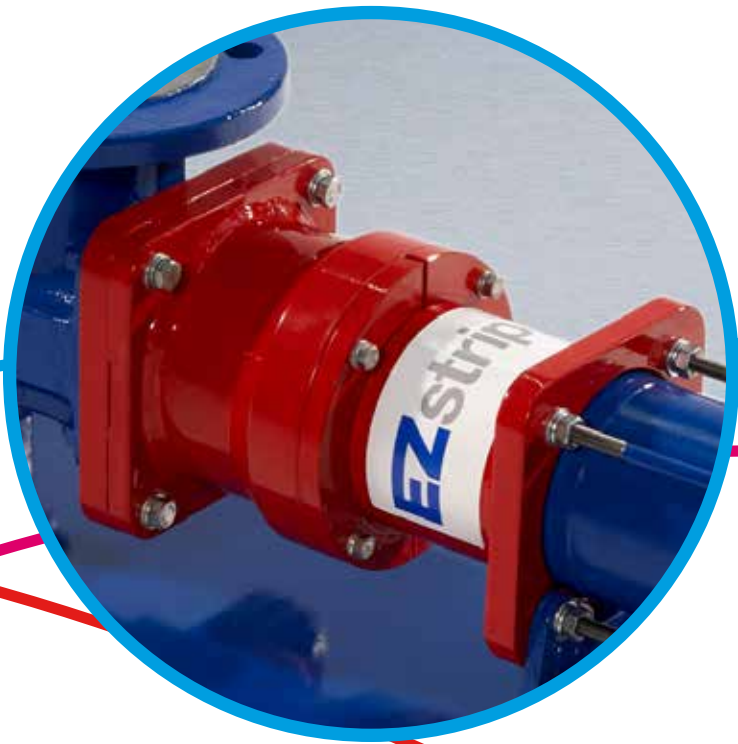

NOV Monoflo®

One Company, Unlimited Solutions

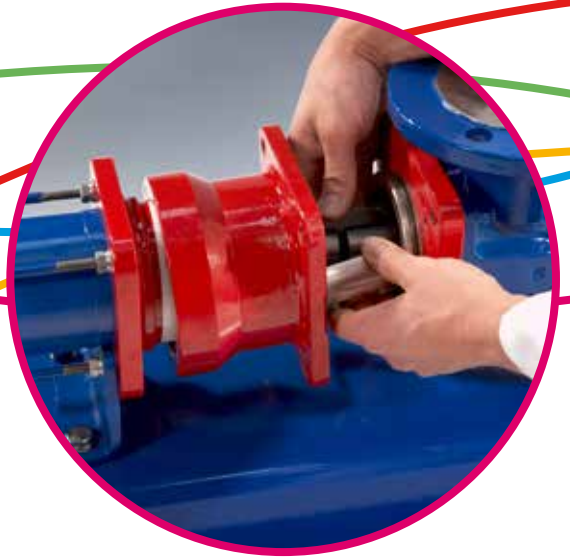

Pump Challenge

Traditional progressing cavity (PC) pump maintenance requires full removal from the pipe work to replace the pump's rotor, stator, and connecting rod assembly. This job is strained by reduced maintenance budgets and diminishing in-house expertise.

EZ Solution

NOV Monoflo's EZstrip™ Transfer Pump is designed to be "Maintained-in-Place", reducing maintenance time from hours to minutes for significant time and cost savings.

Maintain-in-Place Capabilities

- Reduces the time and effort required for maintenance
- No electrical disconnection for quick and easy removal of rotating parts
- Eliminates the need for dismantling length
- Requires only a wrench and an allen key to maintain

Patented split coupling eliminates the need for dismantling space delivering significant time and cost savings

Pre-assembled drive train available with 2-year warranty

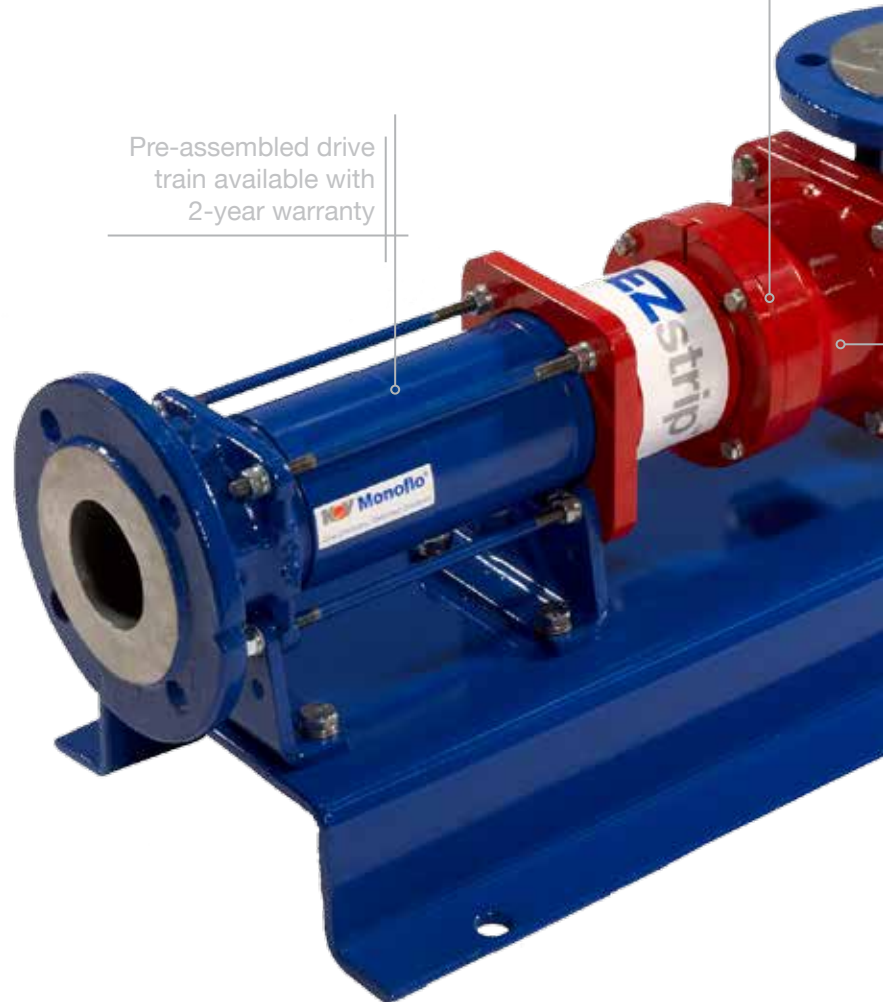



Detachable feed chamber allows for easy maintenance without disconnection from the pipe work

Stainless steel cast components and fasteners provide corrosion resistance making them suitable for a variety of applications

No De-rating Needed

Operational parameters unaffected since design has no effect on flow and pressure

Eliminate Dismantling Length During Maintenance

Suction and discharge ports remain connected to the pipe work

Reduce Cost of Ownership

Minimize spares consumption due to easy de-rag and less dry run occurrences

Interchangeability

Compatible with new pumps or retrofitted into existing Compact C and B-Range installations

Short Lead Times

Fully stocked inventory means less downtime in day-to-day operations



Time and Cost Savings

The EZstrip™ Transfer Pump provides a quick and easy way to disassemble, de-rag, and maintain a PC pump in place, reducing maintenance time by more than 93% for significant cost savings.

You'll save more than \$16,500 over the life of one EZstrip™ Transfer Pump compared to a standard PC pump.

To see the EZstrip™ Transfer Pump in action, visit www.EZstrip.com.

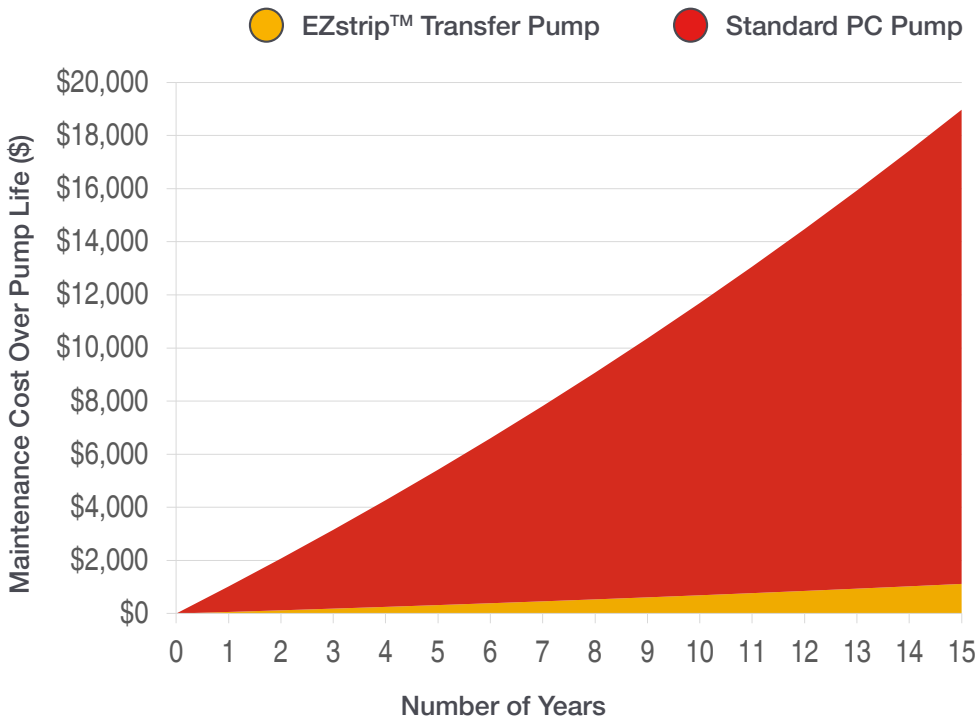

Maintenance Time

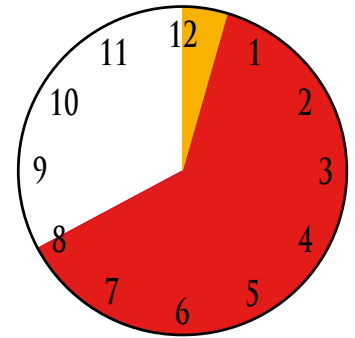

EZstrip™ Transfer Pump reduces maintenance time from eight hours to thirty minutes.

De-Ragging Time

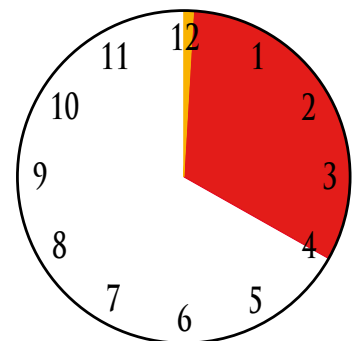

EZstrip™ Transfer Pump reduces de-ragging time from four hours to six minutes.

Assumptions: Labor cost per hour is \$60, pump type is Z16K, flow rate is 75 gallons at 359 rpm, pump life is 15 years, twice a year for maintenance intervention, inflation rate of 3%

Performance Data

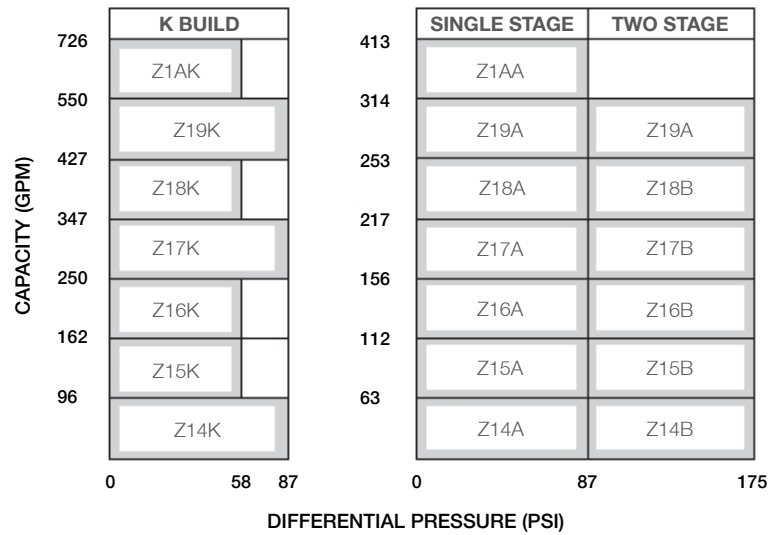

Dimensions

MODEL	A	B	N	P
Z14K	38.8	29.8	4.4	9.0
Z15K	43.4	34.7	4.4	9.1
Z16K	50.1	40.8	4.9	10.0
Z17K	58.2	47.2	5.9	12.2
Z18K	65.1	54.1	5.9	12.2
Z19K	73.7	61.3	6.3	13.6
Z1AK	79.6	67.2	6.3	13.6
Z14A	30.8	21.7	4.4	9.0
Z14B	38.8	29.8	4.4	9.0
Z15A	33.2	24.5	4.4	9.1
Z15B	45.6	34.7	4.9	9.6
Z16A	97.8	28.5	4.9	10.0
Z16B	53.4	40.8	5.9	11.0
Z17A	43.7	32.7	5.9	12.2
Z17B	58.2	47.2	5.9	12.2
Z18A	49.0	38.0	5.9	12.2
Z18B	68.6	54.1	6.3	12.6
Z19A	55.5	43.1	6.3	13.6
Z19B	73.7	61.3	6.3	13.6
Z1AA	58.7	46.3	6.3	13.6

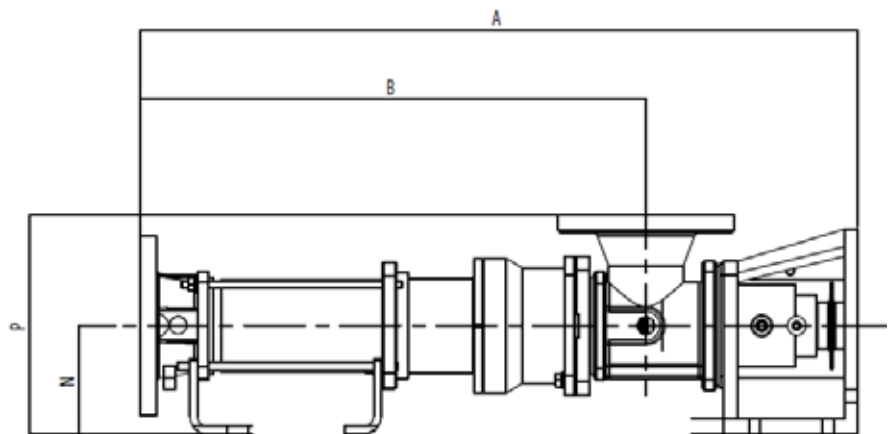

All dimensions are in inches and for guidance only.
For full certified drawings or assistance in selecting a pump, visit www.monoflo.com.

United States of America

Houston, Texas
+1 281 854 0300
monoflo@nov.com

Argentina

Buenos Aires
+54 11 4290 9940/50
monoflo@nov.com

Canada

Lloydminster, Alberta
+1 780 875 5504
info.monoflo@nov.com

France

Rebeville, Lorraine
+33 (0)3 29 94 26 88
monofrance@nov.com

New Zealand

Auckland
+64 (0)9 829 0333
info@mono-pumps.co.nz

United Kingdom

Manchester, England
+44 (0)161 339 9000
info-mono@nov.com

China

Shanghai
+86 (0)21 3990 4588
monoshanghai@nov.com

Australia

Melbourne, Victoria
1 (800) 333 138
ozsales@nov.com



Published information other than marked CERTIFIED does not extend any warranty or representation, expressed or implied, regarding these products. Any such warranties or other terms and conditions of sales and products shall be in accordance with NOV Monoflo's standard terms and conditions of sale available for request.

NOV Monoflo® products are marketed outside North America under the trademark NOV Mono®.

Literature reference: EZP-R2 2012

NOV Monoflo® is a registered trademark of Mono Pumps Ltd.



www.monoflo.com